

bizhub PRESS C71hc

Spec sheet

System Configuration

*1 The WT-511 can not be installed when you connect the PF-602m and the PF-707.

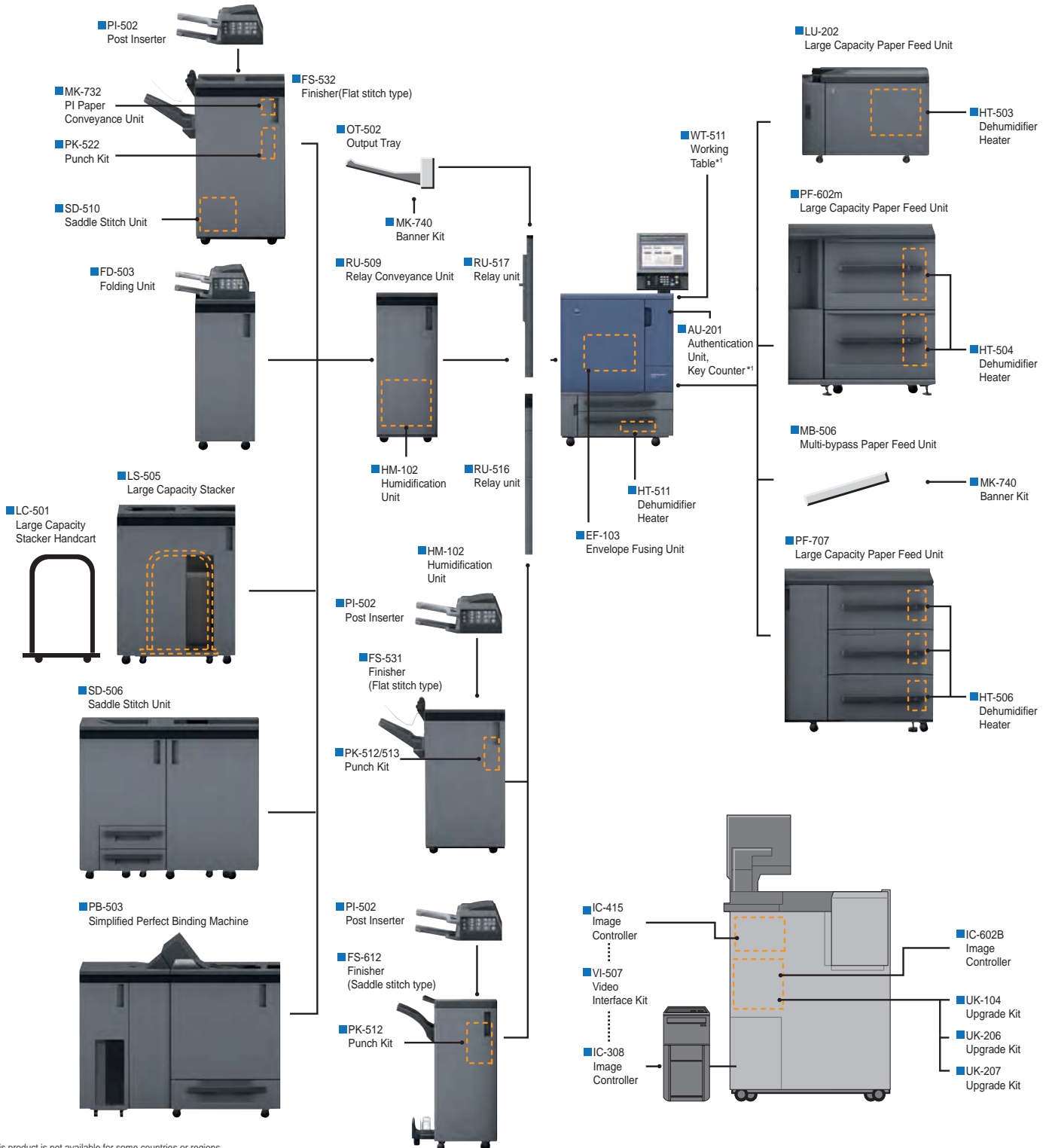

This product is not available for some countries or regions.

■ bizhub PRESS C71hc General Specifications

Type	Console type	
Copy Method	4-coupled drum tandem laser electrostatic method	
Resolution	1,200 dpi (Equivalent to 3,600 dpi) x 1,200 dpi	
Gradation	8-bit / 256 Gradation	
CPU	Core i5 2400 3.1 GHz	
System Memory Capacity	2 GB	
Extended Memory	System memory capacity can be extended up to 14GB with IC-602 or UK-104.	
Max. Printing Area	323 mm x 480 mm	
Paper Size (S: Short Edge Feed )	Standard tray	SRA3, A3, B4, A4, B5, 13x19, 11x17, 8 1/2x14, 8 1/2x11, 5 1/2x8 1/25 Tab paper (A4, 8 1/2 x 11) Max. 330mm x 487mm, Min. 140mm x 182mm
	Bypass tray (Option)	Max. 330mm x 487mm, Min. 100mm x 148mm
Image Loss	Max. 4 mm or less for top edge, Max. 4.5 mm or less for bottom edge, Max. 3.0 mm or less for right/left edges	
Warm-Up Time	390 seconds or less	
First Copy Out Time	Colour	7.1 sec. or less
	Black and White	5.9 sec. or less
Print Speed (Colour, B&W)	A4	71 ppm
	A3	38 ppm
Tray Capacity (80 g/m ²)	Standard	Tray 1 (500 sheets) Tray 2 (1,000 sheets)
	Option	MB-506 (Multi-bypass, 250 sheets)*1*2 PF-602m (3,000 sheets x 2)*1 PF-707 (1,390 sheets x 2, 1,850 sheets x 1)*1 LU-202 (2,500 sheets)*1
Paper Weight	Standard	62 g/m ² to 256 g/m ² *3
	Option	MB-506/PF-602m/PF-707/LU-202: 62 g/m ² to 300 g/m ²
Continuous Copy Count	Up to 9,999 sheets	
Power Source	Inch: AC208 to 240V 21A 60 Hz Metric: AC220 to 240V 20A, 50 Hz / 60 Hz	
Power Consumption	Inch: 4,900W or less (Main body only) Metric: 4,700W or less (Main body only)	
Dimensions [W] x [D] x [H]	760 mm ^{*4} x 903 mm ^{*5} x 1,041 mm ^{*6} 29.92 ^{*4} x 35.55 ^{*5} x 40.98 ^{*6} (Main body only)	
Weight	Approximately 286 kg / 630 lb (Main body only)	

*1 MB-506, PF-602m, PF-707 and LU-202 are the options.

*2 PF-602m and PF-707 are not available when MB-506 is installed.

*3 For paper size A4 or smaller than 8 1/2x11, it is up to 216 g/m².

*4 Excluding the control panel, output tray, work table.

*5 Including the rear duct.

*6 Height to the top of the main body excluding the control panel.

■ bizhub PRESS C71hc Print Controller

▶ Image Controller IC-308

Type	Server
CPU	Core i5 2400 3.1 GHz
Memory	4 GB
HDD	1 TB
Page-description Language	Adobe PostScript 3 (3020), PDF 1.7, PPML 2.2, APPE 3.0, PCL 5/6 emulation
Printing Method	TCP/IP, SNMP, SMB, FTP, LPR, IPP, Bonjour
Applicable OS	Windows Vista / 7 / 8 / Server 2003 / Server 2008 Server 2008*1 MacOSX 10.5 / 10.6 / 10.7 / 10.8
Interface	10 / 100 / 1000Base-T
Scanner Resolution	200 / 300 / 400 / 600 dpi
Data Format	PDF, TIFF, JPEG
Driver	Twain Plug-in

*1 Including 64-bit versions.

▶ Image Controller IC-602B

Type	AIO to the engine (option)
CPU	Conforms with main unit specification
Memory	Max. 14 GB Details: 2 GB + 4 GB x 2 (IC-602B) + 4 GB (UK-104)
HDD	Max. 2 TB Details: 500 GB x 3 (IC-602B) + 500 GB (UK-104)
Page-description Language	Adobe PostScript3 (PS3020), PDF direct print (PDF version 1.7), APPE (version 2.6) (UK-104 or UK-207 is required), PDF/VT (version 2) (UK-104 or UK-207 is required), TIFF direct print (TIFF version 6 compliance), PPML (version 2.2), PCL-5c compatible, PCL XL (PCL6 version 3) compatible
Printing Method	Pserver (IPX/SPX), LPD / LPR (TCP/IP), IPP (TCP/IP), AppleTalk (EtherTalk), Bonjour (TCP/IP), Web service printing (TCP/IP), NPrinter / RPrinter (IPX/SPX), Raw Port (TCP/IP), SMB
Applicable OS	PS Plug-in Windows Server 2003 / Vista / Server 2008 / 7 / 8 / Server 2012*1 MacOSX 10.5 / 10.6 / 10.7 / 10.8 (PPC/Intel) PS PPD*2 Windows Server 2003 / Vista / Server 2008 / 7 / 8 / Serv er 2012*1 Linux CUPS
Interface	Ethernet (1000BASE-T / 100Base-TX / 10Base-T) with IPv6, USB
Scanner Resolution	200 / 300 / 400 / 600 dpi
Data Format	PDF, TIFF, JPEG, XPS
Driver	HDD Twain Driver, Real Time Mode Twain Driver

*1 Includes 64-bit.

*2 WHQL is not obtained for the PS PPD driver

▶ Image Controller IC-415

Type	Embedded
CPU	Intel pentium G850 2.9GHz
Memory	2 GB
HDD	500GB SATA
Page-description Language	Adobe PostScript3 (PS3020), PDF 1.7, PCL 5/6 emulation
Printing Method	TCP/IP, SNMP, SMB, FTP, LPR, IPP, Bonjour
Applicable OS	Windows Vista / 7 / 8 / Server 2003 / Server 2008*1 MacOSX 10.5 / 10.6 / 10.7 / 10.8
Scanner Resolution	200 / 300 / 400 / 600 dpi
Data Format	PDF, TIFF, JPEG
Driver	Twain Plug-in

*1. Including 64-bit versions.

■ Options

▶ Multi-bypass Paper Feed Unit MB-506

Paper Weight	62 g/m ² to 300 g/m ²
Paper Size	Max. 330 mm x 487 mm, Min. 100 mm x 148 mm
Tray Capacity	250 sheets (80 g/m ²)
Power Source	Supplied from the main body
Power Consumption	Max. 28W or less
Dimensions [W] x [D] x [H]	485 mm x 503 mm x 327 mm 19.09" x 19.8" x 12.87"(Max. dimensions of the whole unit)
Weight	Approximately 4.2 kg / 9.26 lb



▶ Envelope Fuser Unit EF-103

Envelope weight	70 g/m ² to 100 g/m ²	
Envelope Size	Paper length in the main scan direction	100 mm to 245 mm*
	Paper length in the sub scan direction	148 mm to 375 mm
Power Source	Supplied from the main body.	
Power Consumption	2430W or less	
Dimensions [W] x [D] x [H]	200 mm x 690 mm x 235 mm (7.87"x27.17"x9.25")	
Weight	Approximately 16 kg / 35.2lb	

* When the paper length is less than 139.7 mm, paper feed assist parts must be connected.

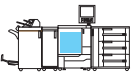

▶ Paper Feeder Unit PF-707

Paper Size	SRA3, A3, B4, A4, B5, A5, 13x19, 12x18, 11x17, 9x11, 8 1/2x14, 8 1/2x11 Tab paper (A4, 8 1/2x11) Max. 330.2 mm x 487.7 mm, Min. 100 mm x 140 mm*1	
Paper Type	Plain, Fine, Color, Coated, Envelope*2	
Paper Weight	62 g/m ² to 300 g/m ²	
Max. Tray Capacity (80 g/m ²)	Upper & Middle Tray	1,390 sheets each
	Bottom Tray	1,850 sheets
	Total	4,630 sheets
Power Source	Inch : 120VAC, Metric : 230VAC	
Dimensions [W] x [D] x [H]	996 mm x 772 mm x 1038 mm / 39.21" x 30.39" x 40.87"	
Weight	203 kg / 447.4 lb	

*1 For the paper whose width is less than 140 mm, use the small size guide.

*2 Only upper tray supports envelopes.

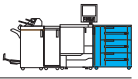

▶ Paper Feeder Unit PF-602m

Paper Size	SRA3, A3, B4, A4, B5, A5, 13x19, 12x18, 11x17, 9x11, 8 1/2x14, 8 1/2x11 Tab paper (A4, 8 1/2x11) Tray (upper): Max. 330 mm x 487 mm, Min. 100 mm x 182 mm Tray (lower): Max. 330 mm x 487 mm, Min. 100 mm x 148 mm	
Paper Type	Plain, Fine, Coated paper	
Paper Weight	Upper Tray	62 g/m ² to 256 g/m ²
	Lower Tray	62 g/m ² to 300 g/m ²
Max. Tray Capacity (80 g/m ²)	6,000 sheets (3,000 sheets x2)	
Power Source	Supplied both from the main body.	
Max. Power Consumption	DC: 90W or less, AC: 100W or less	
Dimensions [W] x [D] x [H]	947 mm x 750 mm x 1,045 mm / 37.28" x 29.53" x 41.14"	
Weight	Approximately 170 kg / 374.78 lb	

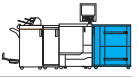

▶ Large Capacity Unit LU-202

Paper Size	SRA3, A3, B4, A4, B5, 13x19, 12x18, 11x17, 9x11, 8 1/2x14, 8 1/2x11 Tab paper (A4, 8 1/2x11) Max. 330 mm x 487 mm, Min. 210 mm x 182 mm*1
Paper Type	Plain, Fine, Coated paper
Paper Weight	62 g/m ² to 300 g/m ²
Paper Capacity (80 g/m ²)	2,500 sheets*2
Power Source	Supplied both from the main body.
Max. Power Consumption	DC: 70W or less AC: 50W or less (Not including HT-503)
Dimensions [W] x [D] x [H]	710 mm x 639 mm x 477 mm / 27.95" x 25.16" x 18.78"
Weight	Approximately 42 kg / 92.59 lb

*1 Available types of paper weighing 300 g/m² are limited to specific types.

*2 Stacked height 275 mm

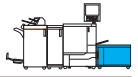

▶ Relay Unit RU-509

Paper Size	Max. 330 mm x 487 mm, Min. 100 mm x 140 mm
Paper Weight	62 g/m ² to 300 g/m ²
Power Source	Supplied from the machine.
Dimensions [W] x [D] x [H]	410 mm x 735 mm x 1,020 mm / 16-1/4" x 29" x 40-1/4"
Weight	Approximately 60 kg / 176-1/4 lb

▶ Paper Humidifier HM-102

Paper Type	Same as the main body.
Power Source	24/5 VDC (Supplied from RU-509)

* For Humidifier ON mode, Envelope or Coated, PrePrinted, Blank Insert Sheet, Embossed, and Embossed2 with the weight under 135 g/m² or less cannot be used.

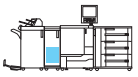

Specifications

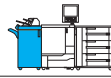

Finisher FS-531

Paper Weight (Staple Mode)		62 g/m ² to 209 g/m ²
Paper Size (Staple Mode)		Max. 314 mm x 458 mm, Min. 182 mm x 148 mm
Paper Capacity (80 g/m ²)	Non-sort mode, Sort/group mode	Max. 3,000 sheets(A4, B5, 8 1/2x11)
	Staple mode	+2 to 9: 100 sets (Direction: 150 mm to 417 mm) / 50 sets (Other) +10 to 20: 50 sets +21 to 30: 30 sets +31 to 40: 25 sets +41 to 50: 20 sets
Stapling Mode Types (Staple Position)	Corner stapling 2 staplings	Parallel or diagonal depending on paper size Center spreading 162 mm pitch
Power Source		Supplied from the main body.
Max. Power Consumption		80W or less
Dimensions [W] x [D] x [H]		424 mm* x 656 mm x 990 mm / 16.69** x 25.82* x 39" Width including the primary (main) tray (with the edge closed): 674.5 mm / 26.56" Width including the primary (main) tray (with the edge pulled out): 790.5 mm / 31.12"
Weight		Approximately 60 kg / 132.28 lb
* Excluding the primary (main) tray		



Finisher FS-612

Paper Weight	Staple / Saddle Stitching / Half-Fold mode	62 g/m ² to 105 g/m ²
Paper Size (S: Short Edge Feed)	Staple mode Saddle stitching mode Half-Fold mode Tri-Folding mode	Max. 314 mm x 458 mm, Min. 182 mm x 148 mm* Max. 314 mm x 458 mm, Min. 210 mm x 279 mm Max. 314 mm x 458 mm, Min. 210 mm x 279 mm A4S, 8 1/2x11S
Paper Capacity (80 g/m ²)	Non-sort mode, Sort / Group mode	Max. 2,500 sheets A4, A4S, B5, 8 1/2x11 1,500 sheets SRA3 **, A3, B4, 12x18, 11x17, 8 1/2x14
Paper Capacity (Booklet Tray)	Saddle Stitching mode Folding mode Tri-Folding mode	Length in the sub scan direction: 299 mm or less: 15 sets with 5 sheets Other than the above: 20 sets with 5 sheets Length in the sub scan direction: 299 mm or less: 25 sets with 3 sheets folding Other than the above: 33 sets with 3 sheets folding 50 sets with 1 sheet folding
Paper Weight		62 g/m ² to 300 g/m ²
Paper Capacity (Sub Tray)	Paper Weight	Max. 100 sheets SRA3, A3, B4, A4, 13x19, 12x18, 11x17, 9x11, 8 1/2x14
Power Source		Supplied from the main body.
Max. Power Consumption		80W or less
Dimensions [W] x [D] x [H]		424 mm** x 656 mm x 990 mm / 16.69** x 25.83* x 39" Width including the primary (main) tray (with the edge closed): 674.5 mm / 26.56" Width including the primary (main) tray (with the edge pulled out): 790.5 mm / 31.12"
Weight		65kg/ 143.3 lb
*1 Non-sort mode only *2 Excluding the primary (main) tray		

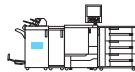

Punch Kit PK-512

Hole Pitch	PK-512	80 mm (2 holes / 4 holes), 108 mm (3 holes)
Paper Weight		62 g/m ² to 128 g/m ²
Paper Size	PK-512	2 holes: A3, B4, A4, B5, 11x17, 8 1/2x14, 8 1/2x11 3/4 holes: A3, B4, A4, B5, 11x17, 8 1/2x11
Power Source		Supplied from the main body.
Max. Power Consumption		40W or less
Dimensions [W] x [D] x [H]		130 mm x 470 mm x 115 mm / 5.12" x 18.5" x 4.53"
Weight		Approximately 3 kg / 6.61 lb

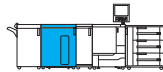

Large Capacity Stacker LS-506

Paper Size	Stacker tray mode Sub tray mode	Max. 331 mm x 483 mm, Min. 210 mm x 148 mm Max. 330 mm x 487 mm, Min. 100 mm x 148 mm
Paper Weight	Stacker tray mode Sub tray mode	62 g/m ² to 300 g/m ² 62 g/m ² to 300 g/m ²
Paper Capacity(80 g/m ²)	Stacker tray mode Sub tray mode	Max. 5,000 sheets 200 sheets (Z-Fold: 20 sheets, Centre-Fold: 40 sheets)
Power Source		Supplied from the main unit
Max. Power Consumption		100VAC to 240VAC, 5VDC (supplied from the main body)
Dimensions [W] x [D] x [H]		785 mm x 723 mm x 1,020 mm / 30" x 28-1/2" x 48-1/2"
Weight		Approximately 110 kg / 242-1/2 lb



Finisher FS-532

Paper Weight		Staple mode: 62 g/m ² to 300 g/m ² Straight / Shift mode: 62 g/m ² to 300 g/m ²
Paper Size	Staple mode Straight/Shift mode	Max. 330 mm x 488 mm, Min. 203 mm x 148 mm Max. 330 mm x 487 mm, Min. 100 mm x 148 mm (Using small size guides)
Paper Capacity (80 g/m ²)		Max. 4,500 sheets (Main + Sub tray)
Stapling Mode Types		Corner stapling: Horizontal, Vertical 2-point stapling: Centre
Power Source		Supplied from the machine
Max. Power Consumption		144W or less
Dimensions [W] x [D] x [H]		544 mm x 723 mm x 1,070 mm / 21-1/2" x 28-1/2" x 42-1/4"
Weight		74 kg / 163-1/4 lb



Punch Kit PK-522

Applicable		Finisher FS-532
Hole Pitch		Metric area: 80 mm (2 holes / 4 holes), 21 mm, 70 mm, 21 mm (Swedish 4 holes) Inch area: 70 mm (2 holes), 108 mm (3 holes)
Paper Weight		62 g/m ² to 300 g/m ²
Paper Size		2 holes: A3, B4, A4, B5, 11x17, 9x11, 8 1/2x14, 8 1/2x11 3/4 holes: A3, B4, A4, B5, 11x17, 9x11, 8 1/2x11
Power Source		Supplied from the main unit
Dimensions [W] x [D] x [H]		156 mm x 592 mm x 180 mm / 6-1/4" x 23-1/4" x 7-1/4"
Weight		4.5 kg / 9.92 lb

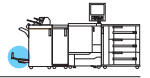

Saddle Stitcher SD-510

Paper Size (S: Short Edge Feed)	Saddle stitch Centre-Fold Fold & Staple Three Fold-in	SRA3, A3, B4, A4, 13x19, 12x18, 11x17, 8 1/2x14, 8 1/2x11S Max. 330 mm x 487 mm, Min. 120 mm x 240 mm A4S, 8 1/2x11
Fold Mode	Saddle Stitch (330 mm or more in length) Centre-Fold Three Fold (less than 330 mm in length)	2 to 5 sheets: 35 sets, 6 to 10 sheets: 23 sets, 11 to 25 sheets: 15 sets 1 to 5 sheets: 35 sets 1-sheet fold: 50 sets, 2-sheet fold: 40 sets, 3-sheet fold: 30 sets
Sheets Saddle Stitch		Max. 20 sheets
Sheets Folded	Centre-Fold Three Fold-in	Max. 5 sheets Max. 3 sheets
Power Source		Supplied from the main unit
Dimensions [W] x [D] x [H]		281 mm x 596 mm x 530 mm / 11.07" x 23.48" x 20.86"
Weight		Approximately 26.4 kg / 58-1/4 lb
*Usable paper types will vary according to function and paper exit destination.		

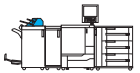

Post Inserter PI-502 *Optional Mount Kit MK-732 with FS-532 is required.

Paper Size	Upper Tray Lower Tray	A4, B5, A5, 9x11, 8 1/2x11 SRA3, A3, B4, A4, B5, A5, 12x18, 11x17, 8 1/2x14, 8 1/2x11
Paper Capacity (80 g/m ²)		Max. 200 sheets
Power Source		Supplied from Finisher FS-532
Dimensions [W] x [D] x [H]		511 mm x 620 mm x 220 mm / 20-1/4" x 24-1/2" x 8-3/4"
Weight		Approximately 10.5 kg / 23-1/2 lb



Folding Unit FD-503

Hole Pitch		Metric area: 80 mm (2 holes / 4 holes) Inch area: 70 mm (2 holes), 108 mm (3 holes)
Fold Types		Centre-fold, Three fold-in, Three fold-out, Double parallel, Z-fold, Gatefold
Paper Size	Hole Punch Folding mode Post insertion mode Straight mode	2 holes: SRA3, A3, B4, A4, B5, 12x18, 11x17, 8 1/2x14, 8 1/2x11 3/4 holes: SRA3, A3, B4, A4, B5, 12x18, 11x17, 8 1/2x11 Max. 305 mm x 458 mm, Min. 210 mm x 279 mm Max. 331 mm x 483 mm, Min. 182 mm x 139 mm Max. 330 mm x 483 mm, Min. 182 mm x 148 mm
Paper Weight	Punch Folding mode Post insertion mode Straight mode Sub Tray mode	62 g/m ² to 216 g/m ² Centre-Fold / Three Fold-in / Three Fold-out / Z-Fold: 62 g/m ² to 130 g/m ² Double Parallel / Gatefold: 62 g/m ² to 91 g/m ² 62 g/m ² to 300 g/m ² 62 g/m ² to 300 g/m ² 62 g/m ² to 300 g/m ²
Power Source		100VAC to 240VAC, 5VDC (supplied from the main body)
Dimensions [W] x [D] x [H]		400 mm* x 723 mm x 1,231 mm / 15-3/4" x 28-1/2" x 48-1/2"
Weight		Approximately 130 kg / 285-1/2 lb
*1 Width including the primary (main) tray (with the edge closed): 667 mm Width including the primary (main) tray (with the edge pulled out): 784 mm		



Saddle Stitcher SD-506

Paper Size (S: Short Edge Feed)	Saddle Stitch/ Trimming Folding Straight (Sub Tray)	SRA3, A3, B4, A4S, 12x18, 11x17, 8 1/2x14, 8 1/2x11S Max. 324 mm x 463 mm, Min. 182 mm x 257 mm Centre-Fold: SRA3, A3, B4, A4S, B5S, 12x18, 11x17, 8 1/2x14, 8 1/2x11 Max. 324 mm x 463 mm, Min. 182 mm x 257 mm Three Fold-in: A4S, 8 1/2x11S Max. 330 mm x 483 mm, Min. 100 mm x 148 mm
Paper Weight		Saddle Stitch / Trimming: 62 g/m ² to 244 g/m ² Centre-Fold: 62 g/m ² to 244 g/m ² Three Fold-in: 62 g/m ² to 91 g/m ² Straight (Sub Tray): 62 g/m ² to 300 g/m ² **
Stitching Capacity		Max: 50 sheets (62 g/m ² to 81 g/m ²)
Trimming Capacity		50 sheets (80 g/m ²)
Fold Type		Centre-Fold, Three Fold-in
Folding Capacity		Centre-Fold: 30 sets Three Fold-in: 20 sets
Power Source		Supplied from the main unit
Max. Power Consumption		100VAC to 240VAC, 5VDC (supplied from the main body)
Dimensions [W] x [D] x [H]		When the stack output tray closed: 1,170 mm x 775 mm x 1,020 mm / 46" x 30-1/2" x 40-1/4"
Weight		280 kg / 617-1/4 lb
**1 Loading paper weight 49g/m ² or less is not warranty.		

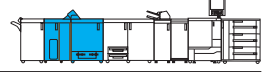

Perfect Binder PB-503

Paper Weight	Body Cover	64 g/m ² to 105 g/m ² 81 g/m ² to 209 g/m ²
Paper Size	Body Cover	Max. 307 mm x 221 mm, Min. 139 mm x 210 mm Max. 307 mm x 472 mm, Min. 139 mm x 279 mm
Bound Pages (80 g/m ²)		Approximately 300 sheets max. (less than 30mm thick) / Approximately 10 sheets min.
Warm-up Time		Approximately 20 min.
Power Source		Supplied from the machine
Max. Power Consumption		100VAC 50/60Hz common 5VDC (supplied from the main body)
Dimensions [W] x [D] x [H]		1,360 mm x 775 mm x 1,223 mm / 53-1/2" x 30-1/2" x 48-1/4"
Weight		Approximately 270 kg / 595-1/4 lb

Banner Kit MK-740

Applicable models	Feeding system Output system	MB-506 OT-502 TypeB/FS-612**/FS531**
Paper Size		Max.330x1,200mm Min. Width100mm
Paper Weights		128 to 256 g/m ²
Pape Type		Plain, Fine, Coated paper
Capacity		10 sheets (Plain paper) 1 sheets (Coated paper)

** Compatible with new FS-612/FS-531(version2) finisher

** Compatible with modified old FS-612/FS-531(version1) finisher

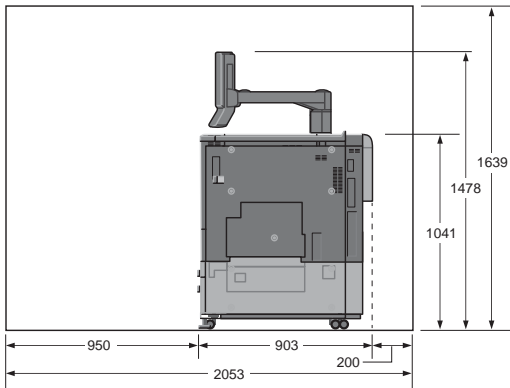

Side View
bizhub PRESS C71hc + RU-517 +
OT-502 + MB-506

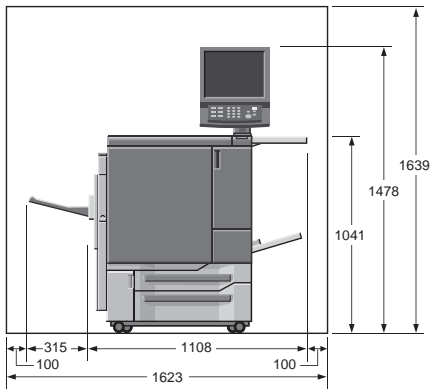

Front View
bizhub PRESS C71hc + RU-517 +
OT-502 + MB-506

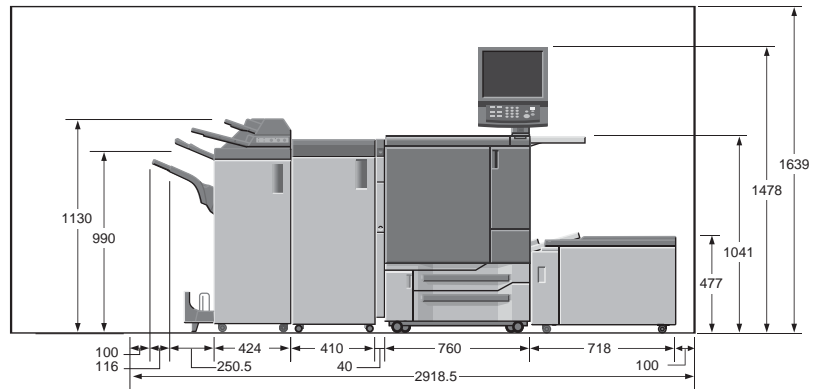

Front View
bizhub PRESS C71hc + RU-516 + FS-612 + RU-509 + LU-202

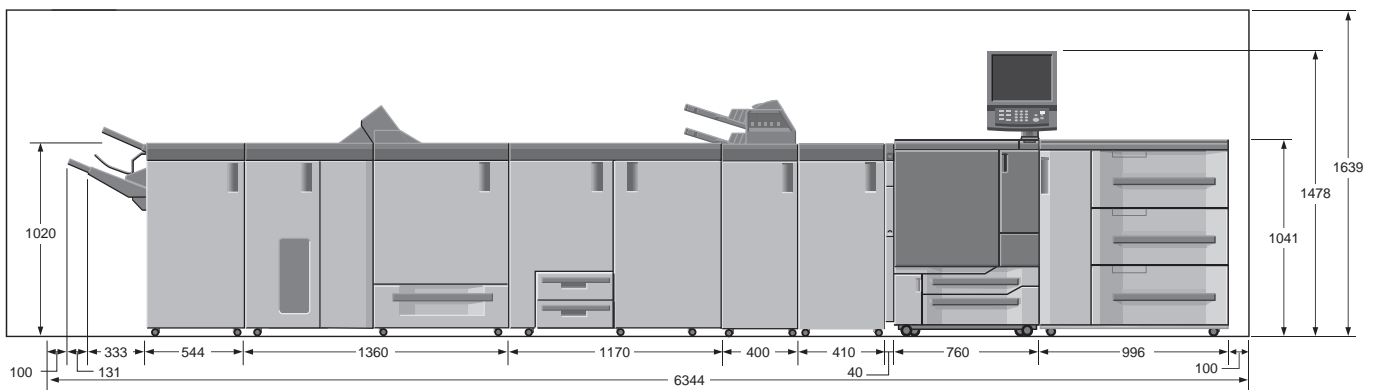

Front View
bizhub PRESS C71hc + RU-516 + FS-532 + PB-503 + SD-506 + FD-503 + RU-509 + PF-707