

# bizhub PRESS C1100/C1085

## Spec sheet

### System Configuration

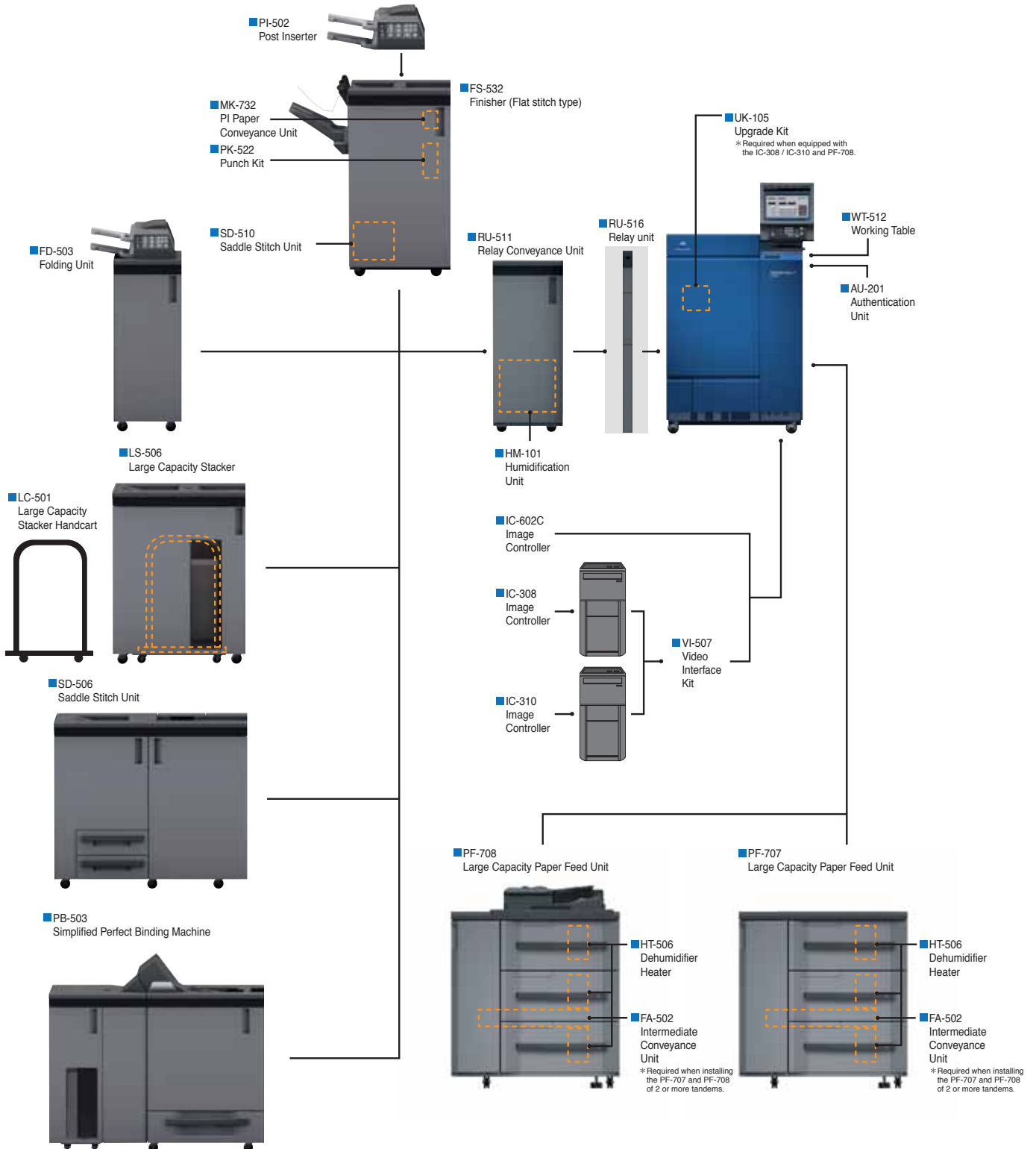

#### Note

1. Either PF-707 or PF-708 must be selected
2. VI-507 is necessary item when selecting IC-308/IC-310
3. One of IC-308/IC-310/IC-602C should be selected for any configuration
4. RU-511 is the mandatory item for any configuration

## ■ bizhub PRESS C1100/C1085 General Specifications

		bizhub PRESS C1100	bizhub PRESS C1085
Type	Console type		
Copy Method	4-coupled drum tandem laser electrostatic method		
Resolution	1,200 dpi (Equivalent to 3,600 dpi) x 1,200 dpi		
Gradation	8-bit / 256 Gradation		
CPU	Core i5 2400 3.1 GHz		
System Memory Capacity	4 GB		
Extended Memory	System memory capacity can be extended up to 14GB with IC-602 or UK-104.		
HDD	1.5 TB		
Max. Printing Area	321 mm x 480 mm		
Output Size (S: Short Edge Feed  )	SRA3, A3, B4, SRA4, SRA4S, A4, A4S, B5, B5S, A5, A5S, B6S, A6S, 13x19, 12x18, 11x17, 9x11, 8 1/2x14, 8 1/2x14S, 8 1/2x11, 8 1/2x11S, 5 1/2x8 1/2, 5 1/2x8 1/2S, 8 1/2x13, 8 1/4x13, 8 1/8x13 1/4, 8x13, 8K, 16K, 16KS Tab paper (A4, 8 1/2x11) Max. 330.2 mm x 487.7 mm, Min. 100 mm x 139.7 mm		
Image Loss	Max. 4 mm or less for top edge, Max. 4 mm or less for bottom edge, Max. 3.0 mm or less for right/left edges		
Warm-Up Time	480 seconds or less		
Continuous Print Speed	Simplex	100 sides/min or 5192 sides/h. (A4)	85 sides/min or 4413 sides/h. (A4)
	Duplex	100 sides/min or 5148 sides/h. (A4)	85 sides/min or 4382 sides/h. (A4)
Paper Weight	55 g/m <sup>2</sup> to 350 g/m <sup>2</sup> (plain, Fine, Colour Specific) 80 g/m <sup>2</sup> to 350 g/m <sup>2</sup> (Coated)		
Power Source	Inch: AC208 to 240V 24A 60 Hz Metric: AC220 to 240V 25A, 50 Hz / 60 Hz		
Power Consumption	Inch: 5,760W or less Metric: 6,000W or less (Maximum power value when the power system of the main body including option is the highest)		
Dimensions [W] x [D] x [H]	900 mm <sup>*1</sup> x 950 mm <sup>*2</sup> x 1,319 mm <sup>*3</sup> 35.43 <sup>*1</sup> x 37.40 <sup>*2</sup> x 51.93 <sup>*3</sup>		
Weight	Approximately 430 kg / 948 lb (Main body only)		

\*1 The operation panel section, the powder smoke suction box, and the working table are not included.  
\*2 Rear side duct is included.  
\*3 The operation panel section is not included.

## ■ bizhub PRESS C1100/C1085 Printer Controller

### ▶ Image Controller IC-308

Type	Server
CPU	Intel Core i5-2400 3.1 GHz
Memory	4 GB
HDD	1 TB
Page-description Language	Adobe PostScript 3 (3020), PDF 1.7, PPML 2.2, APPE 3.0, PCL 5/6 emulation
Printing Method	TCP/IP, SNMP, SMB, FTP, LPR, IPP, Bonjour
Applicable OS	Windows Vista / 7 / 8 / Server 2003 / Server 2008 Server 2008 <sup>*1</sup> MacOSX 10.5 / 10.6 / 10.7 / 10.8
Interface	Gigabit Ethernet (10Base-T / 100Base-Tx / 1000Base-T)
Scanner Resolution <sup>*2</sup>	200 / 300 / 400 / 600 dpi
Data Format <sup>*2</sup>	PDF, TIFF, JPEG
Driver <sup>*2</sup>	Twain Plug-in

\*1 Including 64-bit versions.  
\*2 Only when PF-708 is equipped.

### ▶ Image Controller IC-310

Type	Server
CPU	Xeon E5-2643 3.3 GHz
Memory	16 GB
HDD	500 GB SATA +RAID type 0 (1TB x2 = 2TB)
Page-description Language	Adobe PostScript 3 (3020), PDF 1.7, PPML 2.2, APPE 3.0, PCL 5/6 emulation
Printing Method	TCP/IP, SNMP, SMB, FTP, LPR, IPP, Bonjour
Applicable OS	Windows Vista / 7 / 8 / Server 2003 / Server 2008 Server 2008 <sup>*1</sup> /Server 2008 R2 / Server 2012 MacOSX 10.5 / 10.6 / 10.7 / 10.8
Interface	Gigabit Ethernet (10Base-T / 100Base-Tx / 1000Base-T)
Scanner Resolution <sup>*2</sup>	200 / 300 / 400 / 600 dpi
Data Format <sup>*2</sup>	PDF, TIFF, JPEG
Driver <sup>*2</sup>	Twain Plug-in

\*1 Including 64-bit versions.  
\*2 Only when PF-708 is equipped.

### ▶ Image Controller IC-602C

Type	AIO to the engine (option)
CPU	Conforms with main unit specification
Memory	Max. 16 GB Details: 4 GB (Standard of the main body) + 12 GB (IC-602C)
HDD	Max. 2.5 TB Details: 500 GB x 5
Page-description Language	Adobe PostScript3 (PS3020), PDF direct print (PDF version 1.7), APPE (version 2.6), PDF/VT (version 2), TIFF direct print (TIFF version 6 compliance), PPML (version 2.2), PCL-5c compatible, PCL XL (PCL6 version 3) compatible
Printing Method	Pserver (IPX/SPX), LPD / LPR (TCP/IP), IPP (TCP/IP), AppleTalk, Bonjour (TCP/IP), Web service printing (TCP/IP), NPrinter / RPrinter (IPX/SPX), Raw Port (TCP/IP), SMB
Applicable OS	PS Plug-in Windows Server 2003 / Vista / Server 2008 / 7 / Server 2008R2 / 8 / Server 2012 <sup>*1</sup> MacOSX 10.5 / 10.6 / 10.7 / 10.8 (PPC/Intel) PS PPD <sup>*2</sup> Windows Server 2003 / Vista / Server 2008 / 7 / Server 2008R2 / 8 / Server 2012 <sup>*1</sup> Linux CUPS
Interface	Gigabit Ethernet (10Base-T / 100Base-Tx / 1000Base-T) with IPv6, USB
Scanner Resolution <sup>*3</sup>	200 / 300 / 400 / 600 dpi
Data Format <sup>*3</sup>	PDF, TIFF, JPEG, XPS
Driver <sup>*3</sup>	HDD Twain Driver, Real Time Mode Twain Driver

\*1 Includes 64-bit.  
\*2 WHQL is not obtained for the PS PPD driver  
\*3 Only when PF-708 is equipped.

## ■ Options

### ▶ Paper Feeder Unit PF-707

Paper Size (S: Short Edge Feed  )	SRA3, A3, B4, SRA4, SRA4S, A4, A4S, B5, B5S, A5, A5S, B6S, A6S, 13x19, 12x18, 11x17, 9x11, 8 1/2x14, 8 1/2x14S, 8 1/2x11S, 5 1/2x8 1/2, 5 1/2x8 1/2S, 8 1/2x13, 8 1/4x13, 8 1/8x13 1/4, 8x13 Max. 330.2 mm x 487.7 mm, Min. 100 mm x 139.7 mm <sup>*1</sup> Tab paper (A4, 8 1/2x11) <sup>*2</sup>
Paper Type	Plain, Fine, Color, Coated
Paper Weight	55 g/m <sup>2</sup> to 350 g/m <sup>2</sup>
Max. Tray Capacity	4,630 sheets (80 g/m <sup>2</sup> ) Tray (upper / middle): 1,390 sheets Tray (lower tray): 1,850 sheets
Power Source	Inch : 120VAC, Metric : 230VAC
Dimensions [W] x [D] x [H]	996 mm x 772 mm x 1038 mm / 39.21" x 30.39" x 40.87"
Weight	203 kg / 447.4 lb

\*1 Use the small guide when the width is shorter than 139.7 mm. Only the 1st tandem is available.  
Minimum size of the 2nd tandem is 140 mm x 140 mm.  
\*2 The tab paper guide is required. Supported only for single side printings.

### ▶ Paper Feeder Unit PF-708 (with Scanner unit)

Paper Size (S: Short Edge Feed  )	SRA3, A3, B4, SRA4, SRA4S, A4, A4S, B5, B5S, A5, A5S, B6S, A6S, 13x19, 12x18, 11x17, 9x11, 8 1/2x14, 8 1/2x14S, 8 1/2x11S, 5 1/2x8 1/2, 5 1/2x8 1/2S, 8 1/2x13, 8 1/4x13, 8 1/8x13 1/4, 8x13 Max. 330.2 mm x 487.7 mm, Min. 100 mm x 139.7 mm <sup>*1</sup> Tab paper (A4, 8 1/2x11) <sup>*2</sup>	
Paper Type	Plain, Fine, Color, Coated	
Paper Weight	55 g/m <sup>2</sup> to 350 g/m <sup>2</sup>	
Max. Tray Capacity	4,630 sheets (80 g/m <sup>2</sup> ) Tray (upper / middle): 1,390 sheets Tray (lower tray): 1,850 sheets	
Scanner Resolution	600 dpi x 600 dpi	
Original Type	Sheet, Book, Solid object	
Max. Original Size	A3 or 11x17	
Copy Magnification	Fixed Magnification	Inch : x 1.000, x 2.000, x 1.545, x 1.294, x 1.214, x 0.785, x 0.772, x 0.647, x 0.500 Metric : x 1.000, x 2.000, x 1.414, x 1.189, x 0.840, x 0.707, x 0.500
	Zoom Magnification	x 0.250 to x 4.000 (Each 0.001 step)
Continuous Copy Count	Up to 9,999 sheets	
Power Source	Inch : 120VAC, Metric : 230VAC	
Dimensions [W] x [D] x [H]	996 mm x 772 mm x 1190 mm / 39.21" x 30.39" x 46.85"	
Weight	234 kg / 515.9 lb	
Document Feeder	Paper Type	Normal original mode: Simplex original mode: 35 g/m <sup>2</sup> to 210 g/m <sup>2</sup> Duplex original mode: 50 g/m <sup>2</sup> to 128 g/m <sup>2</sup>
	Paper Size	Mixed original mode: Simplex original mode, Duplex original mode: 50 g/m <sup>2</sup> to 128 g/m <sup>2</sup> A3, B4, A4, A4S, B5, B5S, A5, A5S, B6S, A6S, 11x17, 8 1/2x11, 8 1/2x11S, 8 1/2x14, 5 1/2x8 1/2, 5 1/2x8 1/2S, 8 1/2x13, 8 1/4x13, 8 1/8x13 1/4, 8x13, 8K, 16K, 16KS
Capacity	100 sheets (80 g/m <sup>2</sup> )	
Scan Speed (A4)	Scan Resolution: 600 dpi 42 sheets/min. Scan Resolution: 300 dpi 70 sheets/min.	
Power Source	Supplied from the machine	
Dimensions [W] x [D] x [H]	600 mm x 575 mm x 130 mm / 23.62" x 22.64" x 5.12"	
Weight	Approximately 16.7 kg / 36.82 lb	

\*1 Use the small guide when the width is shorter than 139.7 mm. Only the 1st tandem is available.  
Minimum size of the 2nd tandem is 140 mm x 140 mm.  
\*2 The tab paper guide is required. Supported only for single side printings.



## ▶ Relay Unit RU-511

Paper Size (S: Short Edge Feed <input type="checkbox"/> )	Max. 330.2 mm x 487.7 mm, Min. 100 mm x 139.7 mm
Paper Weight	55 g/m <sup>2</sup> to 350 g/m <sup>2</sup>
Power Source	Supplied from the machine.
Dimensions [W] x [D] x [H]	410 mm x 735 mm x 1,020 mm / 16-1/4" x 29" x 40-1/4"
Weight	Approximately 60 kg / 176-1/4 lb

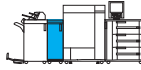

## ▶ Paper Humidifier HM-101

Paper Type	Same as the main body.
Power Source	24/5 VDC (Supplied from RU-511)

\* For Humidifier ON mode, Coated or PrePrinted, Blank Insert Sheet, Embossed, and Embossed2 with the weight under 135 g/m<sup>2</sup> or less cannot be used.

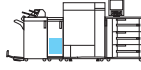

## ▶ Large Capacity Stacker LS-506

Paper Size (S: Short Edge Feed <input type="checkbox"/> )	Stacker tray mode	Max. 330.2 mm x 487.7 mm, Min. 210 mm x 148 mm
	Sub tray mode	Max. 330.2 mm x 487.7 mm, Min. 100 mm x 139.7 mm
Paper Weight	Stacker tray mode	55 g/m <sup>2</sup> to 350 g/m <sup>2</sup>
	Sub tray mode	55 g/m <sup>2</sup> to 350 g/m <sup>2</sup>
Paper Capacity(80 g/m <sup>2</sup> ) (S: Short Edge Feed <input type="checkbox"/> )	Stacker tray mode	Max. 5,000 sheets
	Sub tray mode	200 sheets (Z-Fold: 20 sheets, Centre-Fold: 40 sheets)
Power Source	Supplied from the main unit	
Max. Power Consumption	100VAC to 240VAC, 5VDC (Only 5VDC is supplied from the main body)	
Dimensions [W] x [D] x [H]	785 mm x 723 mm x 1,020 mm / 30" x 28-1/2" x 48-1/2"	
Weight	Approximately 110 kg / 242-1/2 lb	

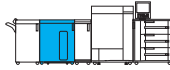

## ▶ Finisher FS-532

Paper Weight	Staple mode: 55 g/m <sup>2</sup> to 350 g/m <sup>2</sup> Straight / Shift mode: 55 g/m <sup>2</sup> to 350 g/m <sup>2</sup>	
Paper Size	Staple mode	Max. 330.2 mm x 487.7 mm, Min. 203 mm x 148 mm
	Straight/Shift mode	Max. 330.2 mm x 487.7 mm, Min. 100 mm x 140 mm
Paper Capacity (80 g/m <sup>2</sup> )	Max. 4,500 sheets (Main + Sub tray)	
Stapling Mode Types	Corner stapling: Horizontal, Vertical 2-point stapling: Centre	
Power Source	Supplied from the machine	
Max. Power Consumption	144W or less	
Dimensions [W] x [D] x [H]	544 mm x 723 mm x 1,070 mm / 21-1/2" x 28-1/2" x 42-1/4"	
Weight	74 kg / 163-1/4 lb	

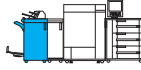

## ▶ Punch Kit PK-522 \*Option of FS-532.

Applicable	Finisher FS-532	
Hole Pitch	Metric area: 80 mm (2 holes / 4 holes), 21 mm, 70 mm, 21 mm (Swedish 4 holes)	
	Inch area: 70 mm (2 holes), 108 mm (3 holes)	
Paper Weight	60 g/m <sup>2</sup> to 300 g/m <sup>2</sup>	
Paper Size (S: Short Edge Feed <input type="checkbox"/> )	2 holes: A3, B4, SRA4S, A4, A4S, B5, B5S, A5, A5S, 11x17, 9x11, 8 1/2x14, 8 1/2x11, 8 1/2x11S, 5 1/2x8 1/2S, 5 1/2x8 1/2, 8 1/2x13, 8 1/4x13, 8 1/8x13 1/4, 8x13, 8K, 16K, 16KS	
	3/4 holes: A3, B4, A4, B5, 11x17, 9x11, 8 1/2x11, 8K, 16K	
	Power Source	Supplied from the main unit
	Dimensions [W] x [D] x [H]	156 mm x 592 mm x 180 mm / 6-1/4" x 23-1/4" x 7-1/4"
	Weight	4.5 kg / 9.92 lb

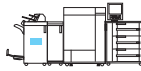

## ▶ Saddle Stitcher SD-510 \*Option of FS-532.

Paper Size (S: Short Edge Feed <input type="checkbox"/> )	Saddle stitch	SRA3, A3, B4, SRA4S, A4S, B5S, 13x19, 12x18, 11x17, 8 1/2x14, 8 1/2x11S, 8 1/2x13, 8 1/4x13, 8 1/8x13 1/4, 8x13, 8K, 16KS
	Centre-Fold	Max. 330.2 mm x 487.7 mm, Min. 120 mm x 240 mm
	Fold & Staple	A4S, 8 1/2x11S, 8K, 16KS
	Three Fold-in	
Fold Mode Tray Capacity	Saddle Stitch (330 mm or more in length)	2 to 5 sheets: 35 sets, 6 to 10 sheets: 23 sets, 11 to 25 sheets: 15 sets
	Centre-Fold	1 to 5 sheets: 35 sets
	Three Fold (less than 330 mm in length)	1-sheet fold: 50 sets, 2-sheet fold: 40 sets, 3-sheet fold: 30 sets
Sheets Saddle Stitch	Max. 25 sheets	
Sheets Folded	Centre-Fold	Max. 5 sheets
	Three Fold-in	Max. 3 sheets
Power Source	Supplied from the main unit	
Dimensions [W] x [D] x [H]	281 mm x 596 mm x 530 mm / 11.07" x 23.48" x 20.86"	
Weight	Approximately 26.4 kg / 58-1/4 lb	

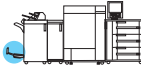

\*Usable paper types will vary according to function and paper exit destination.

## ▶ Post Inserter PI-502 \*Optional Mount Kit MK-732 with FS-532 is required.

Paper Size	Upper Tray	A4, A4S, B5, B5S, A5, 9x11, 8 1/2x11, 8 1/2x11S, 5 1/2x8 1/2, 16K, 16KS
	Lower Tray	SRA3, A3, B4, SRA4S, A4, A4S, B5, B5S, A5, 13x19, 12x18, 11x17, 9x11, 8 1/2x14, 8 1/2x11, 8 1/2x11S, 5 1/3x8 1/2, 8 1/2x13, 8 1/4x13, 8 1/8x13 1/4, 8x13, 8K, 16K, 16KS
Paper Capacity (80 g/m <sup>2</sup> )	Max. 200 sheets(80 g/m <sup>2</sup> )	
Power Source	Supplied from Finisher FS-532	
Dimensions [W] x [D] x [H]	511 mm x 620 mm x 220 mm / 20-1/4" x 24-1/2" x 8-3/4"	
Weight	Approximately 10.5 kg / 23-1/2 lb	

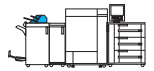

## ▶ Folding Unit FD-503

Hole Pitch	Metric area: 80 mm (2 holes / 4 holes) Inch area: 70 mm (2 holes), 108 mm (3 holes)	
Fold Types	Centre-fold, Three fold-in, Three fold-out, Double-parallel, Z-fold, Gatefold	
Paper Size (S: Short Edge Feed <input type="checkbox"/> )	Hole Punch	2 holes: SRA3, A3, B4, SRA4S, A4, A4S, B5, B5S, A5, A5S, 12x18, 11x17, 9x11, 8 1/2x14, 8 1/2x11, 8 1/2x11S, 5 1/2x8 1/2, 8 1/2x13, 8 1/4x13, 8 1/8x13 1/4, 8x13, 8K, 16K, 16KS 3/4 holes: SRA3, A3, B4, A4, B5, 12x18, 11x17, 9x11, 8 1/2x11, 8K, 16K
	Folding mode	Max. 305 mm x 458 mm, Min. 210 mm x 279 mm
	Post insertion mode	Max. 330 mm x 483 mm, Min. 182 mm x 140 mm
	Straight mode	Max. 330 mm x 483 mm, Min. 182 mm x 140 mm
Paper Weight	Punch	55 g/m <sup>2</sup> to 216 g/m <sup>2</sup>
	Folding mode	Centre-Fold / Three Fold-in / Three Fold-out / Z-Fold: 55 g/m <sup>2</sup> to 130 g/m <sup>2</sup> Double Parallel / Gatefold: 55 g/m <sup>2</sup> to 91 g/m <sup>2</sup>
	Post insertion mode	50 g/m <sup>2</sup> to 300 g/m <sup>2</sup>
	Straight mode	55 g/m <sup>2</sup> to 350 g/m <sup>2</sup>
Power Source	Sub Tray mode	55 g/m <sup>2</sup> to 350 g/m <sup>2</sup>
	100VAC to 240VAC, 5VDC (supplied from the main body)	
	Dimensions [W] x [D] x [H]	400 mm*1 x 723 mm x 1,231 mm / 15-3/4" x 28-1/2" x 48-1/2"
Weight	Approximately 130 kg / 285-1/2 lb	

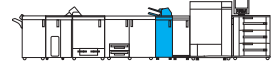

\*1 Width including the primary (main) tray (with the edge closed): 667 mm  
Width including the primary (main) tray (with the edge pulled out): 784 mm

## ▶ Saddle Stitcher SD-506

Paper Size (S: Short Edge Feed <input type="checkbox"/> )	Saddle Stitch/Trimming	SRA3, A3, B4, SRA4S, A4S, B5S, 12x18, 11x17, 8 1/2x14, 8 1/2x11S, 8 1/2x13, 8 1/4x13, 8 1/8x13 1/4, 8x13, 8K, 16KS Max. 324 mm x 463 mm, Min. 182 mm x 257 mm
	Folding	Centre-Fold: SRA3, A3, B4, SRA4S, A4S, B5S, 12x18, 11x17, 8 1/2x14, 8 1/2x11S, 8 1/2x13, 8 1/4x13, 8 1/8x13 1/4, 8x13, 8K, 16KS Max. 324 mm x 463 mm, Min. 182 mm x 257 mm Three Fold-in: A4S, 8 1/2x11S
Paper Weight	Straight (Sub Tray)	Max. 330 mm x 487 mm, Min. 100 mm x 140 mm
	Saddle Stitch / Trimming:	55 g/m <sup>2</sup> to 244 g/m <sup>2</sup>
	Centre-Fold:	55 g/m <sup>2</sup> to 244 g/m <sup>2</sup>
	Three Fold-in:	55 g/m <sup>2</sup> to 91 g/m <sup>2</sup>
Stitching Capacity	Trimming Capacity	50 sheets (80 g/m <sup>2</sup> )
	Max:	50 sheets (62 g/m <sup>2</sup> to 81 g/m <sup>2</sup> )
Fold Type	Centre-Fold, Three Fold-in	
Folding Capacity	Centre-Fold: 30 sets Three Fold-in: 20 sets	
Power Source	Supplied from the main unit	
Max. Power Consumption	100VAC to 240VAC, 5VDC (supplied from the main body)	
Dimensions [W] x [D] x [H]	When the stack output tray closed: 1,170 mm x 775 mm x 1,020 mm / 46" x 30-1/2" x 40-1/4"	
Weight	280 kg / 617-1/4 lb	

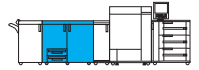

## ▶ Perfect Binder PB-503

Paper Weight	Body: 64 g/m <sup>2</sup> to 105 g/m <sup>2</sup> (81 g/m <sup>2</sup> to 209 g/m <sup>2</sup> for cover sheets)	
Paper Size (S: Short Edge Feed <input type="checkbox"/> )	* Body	Max. 307 mm x 221 mm, Min. 139 mm x 210 mm
	* Cover Paper	Max. 307 mm x 472 mm, Min. 139 mm x 279 mm
Bound Pages (80 g/m <sup>2</sup> )	Approximately 300 sheets max. (less than 30mm thick) / Approximately 10 sheets min.	
Warm-up Time	Approximately 20 min.	
Power Source	Supplied from the machine	
Max. Power Consumption	100VAC 50/60Hz common 5VDC (supplied from the main body)	
Dimensions [W] x [D] x [H]	1,360 mm x 775 mm x 1,223 mm / 53-1/2" x 30-1/2" x 48-1/4"	
Weight	Approximately 270 kg / 595-1/4 lb	

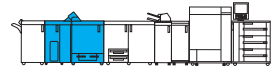

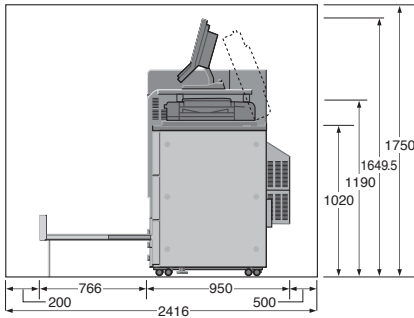

**Side View**  
bizhub PRESS C1100/C1085 +  
SD-506 + RU-511 + RU-516 + Machine + WT-512 + PF-708

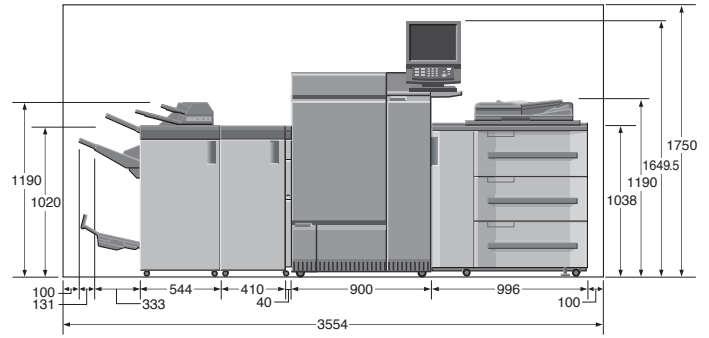

**Front View**  
bizhub PRESS C1100/C1085 +  
FS-532 (PI-502/MK-732/PK-522/SD-510) + RU-511 + RU-516 + Machine + WT-512 + PF-708

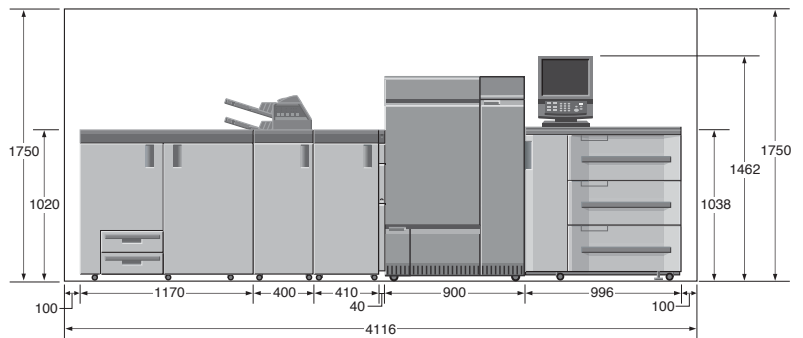

**Front View**  
bizhub PRESS C1100/C1085 +  
SD-506 + FD-503 + RU-511 + RU-516 + Machine + PF-707

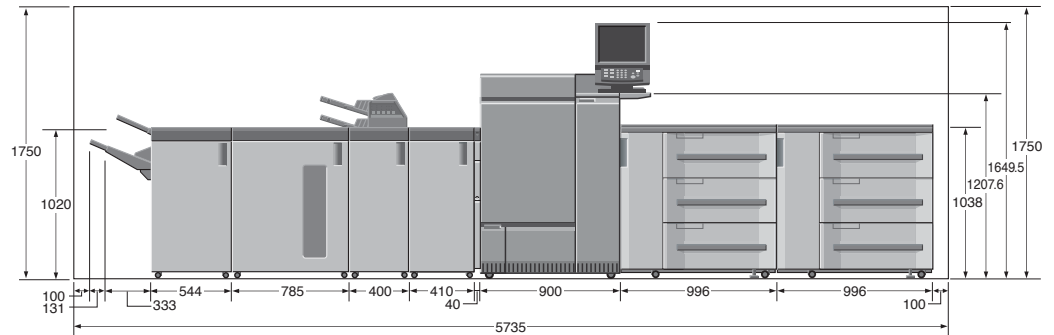

**Front View**  
bizhub PRESS C1100/C1085 +  
FS-532 + LS-506 + FD-503 + RU-511 + RU-516 + Machine + WT-512 + PF-707 + PF-707

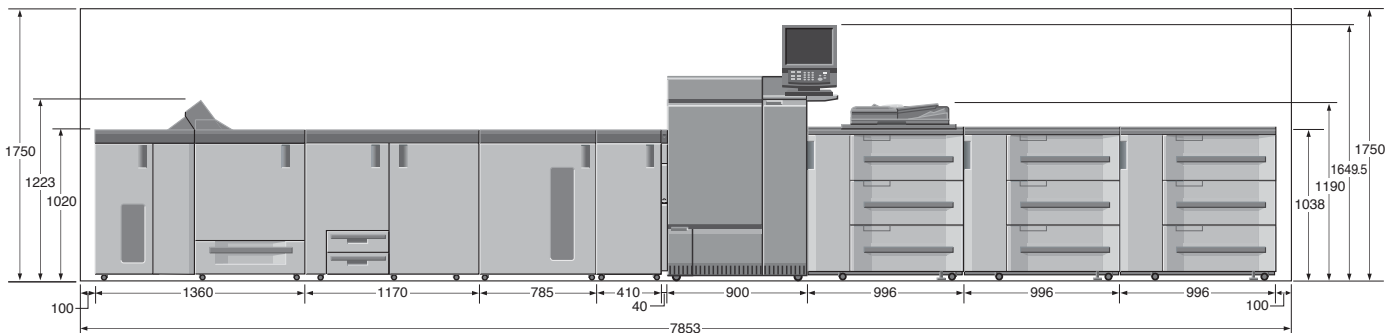

**Front View**  
bizhub PRESS C1100/C1085 +  
PB-503 + SD-506 + LS-506 + RU-511 + RU-516 + Machine + WT-512 + PF-708 + PF-707 + PF-707